

Data Sheet



Article number: 604132022030

Description: Taper bored timing belt pulley
HTD 22 8M 30 TL 1008

Measures

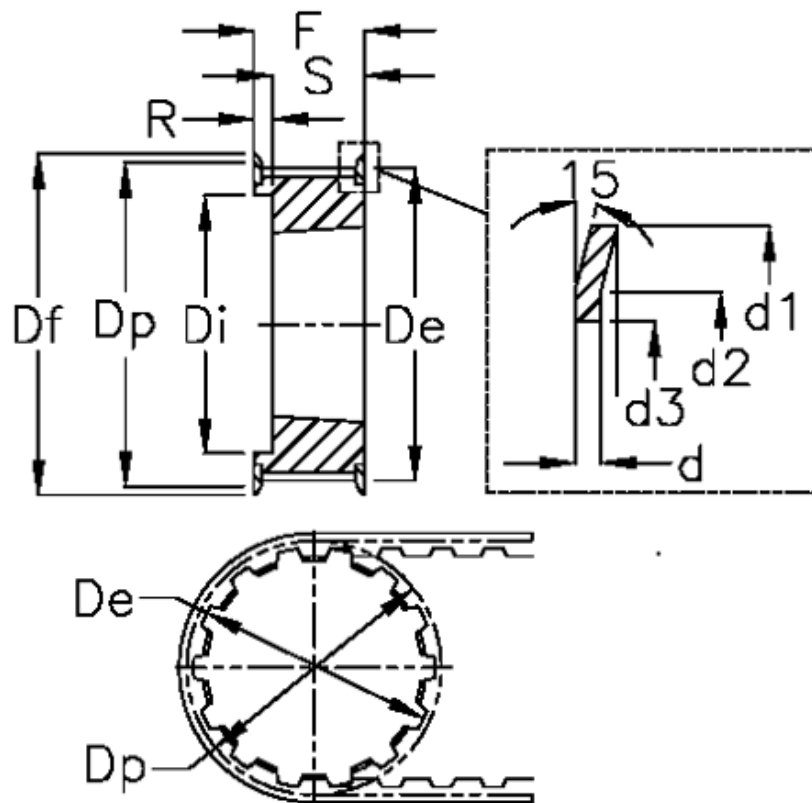

$d = 1.5$	F = 38	Weight = 0.31
$d1 = 60$	Flange type = F22	Width = 30
$d2 = 57$	For bushing = 1008	
$d3 = 47$	Max bore = 25	
$De = 54.65$	r = 16	
$Df = 60$	S = 22	
$Di = 37$	Tooth number = 22	
$Dp = 56.02$	Type = 8M	